

- In addition to routine checks for each use, PPE should regularly undergo a detailed inspection by a competent person. Petzl recommends an inspection every 12 months and after any exceptional event in the life of the product.
 - PPE inspection should be conducted with the manufacturer's Instructions for Use.
- Download the instructions at [PETZL.COM](https://www.petzl.com).

CAM-LOADED ROPE CLAMPS



1. Known product history

Any PPE showing unexpected degradation should be quarantined, pending a detailed inspection.

The user should:

- Provide precise information on the usage conditions.
- Report any exceptional event regarding his PPE.

(Examples: fall or fall arrest, use or storage at extreme temperatures, modification outside manufacturer's facilities...).

2. Preliminary observations

Verify the presence and legibility of the serial number and the CE mark.

Note: the serial number code on our products is evolving. Two types of code will coexist. See below for details on each serial number code.

Code A:

00 000 AA 0000

Year of manufacture
Day of manufacture
Name of Inspector
Incrementation

Code B:

00 A 0000000 000

Year of manufacture
Month of manufacture
Batch number
Incrementation

Verify that the product lifetime has not been exceeded.

Compare with a new product to verify there are no modifications or missing parts.

3. Inspecting the frame

- Check the condition of the frame (marks, cracks, wear, deformation, corrosion...).

- Check for wear caused by rope running through the device.

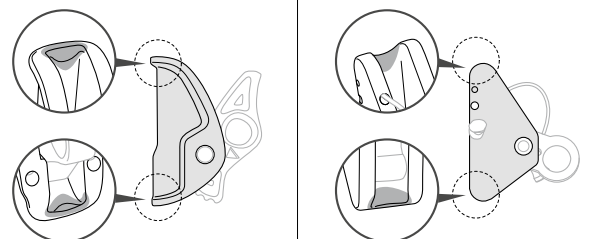
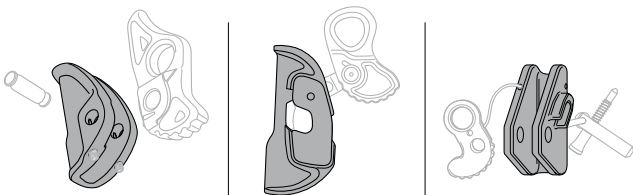

4. Inspecting the cam

- Check the condition of the cam and the attachment hole (marks, cracks, wear, deformation, corrosion...).

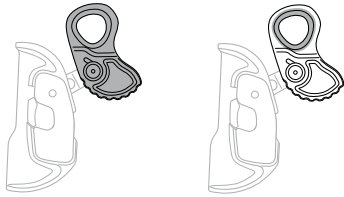

- Check the condition of the cam axle (deformation, cracks, corrosion...).

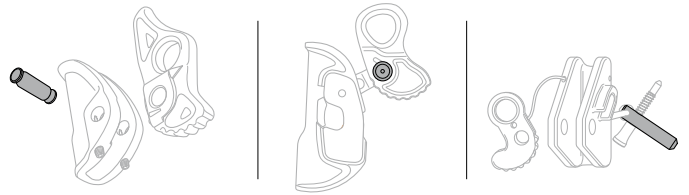

- Check the cam's rotation and the effectiveness of the return spring.

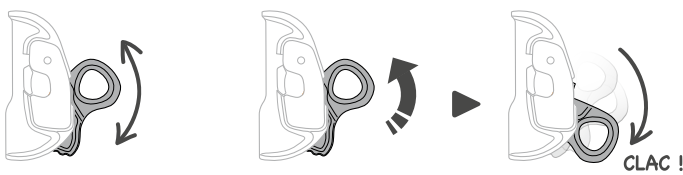

5. Checking the closure system

- Check the condition of the links or screws (deformation, marks, wear, cracks, corrosion...).

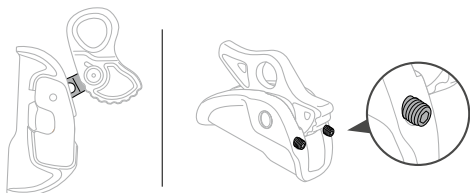

- Check the condition of the safety catches, and verify that the return spring works.

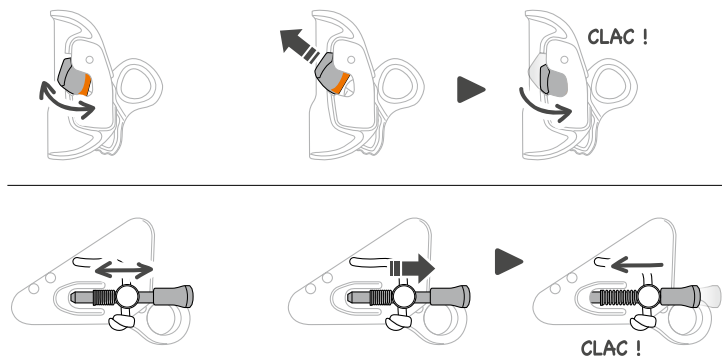

6. Function check

Verify that the rope clamp slides along the rope in one direction and locks in the other direction.

